

DIRECT RELIEF VALVES

HRV SERIES



HYDRAULIC

Hirose Valves

HIROSE HRV series

DIRECT RELIEF VALVE

直動形リリーフ弁

■ 特 徴

- ・ 応答性に優れ、特に安全弁として最適です。また、バランスピストン形リリーフ弁に比べて内部漏れが少なくなっております。
- ・ チャタリングが起こりにくい構造で、作動が安定しております。
- ・ O2～10サイズまで幅広くご用意しております。
- ・ ブレーキ回路で使用できます。

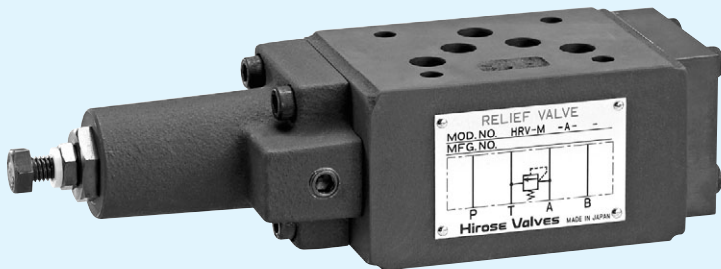

HRV - M03 - A - 25 - 21 (11)

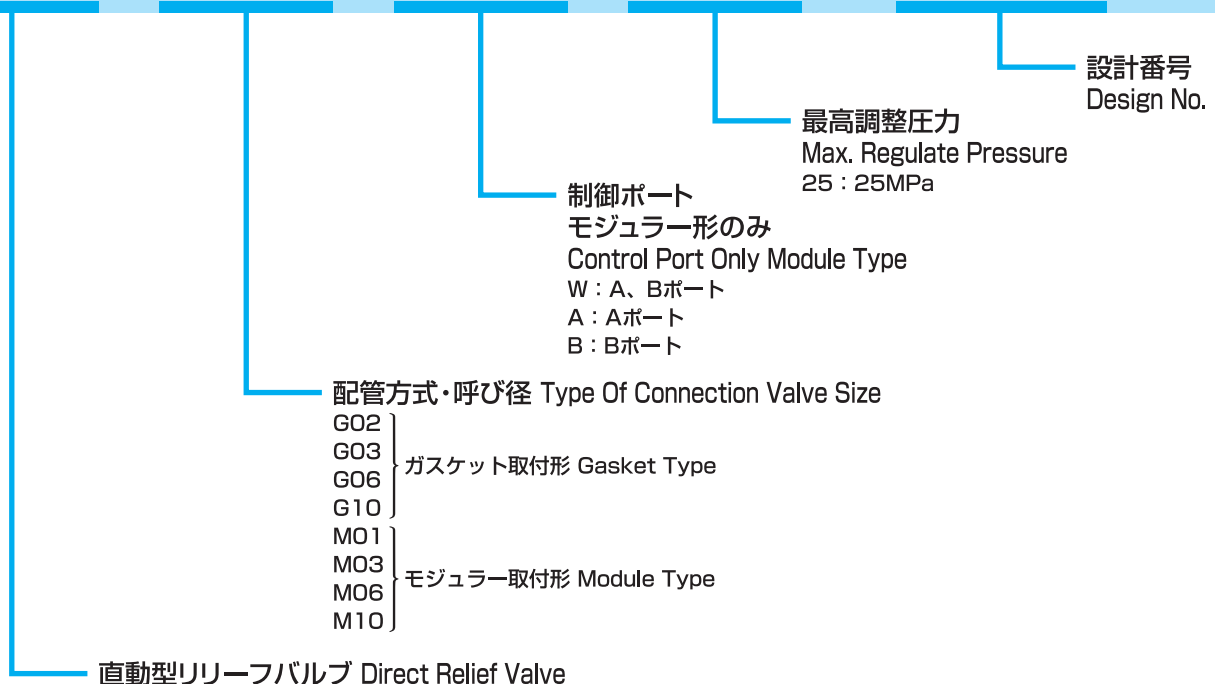

■ バルブ仕様 Valve Specifications

モデルNo. Model Number	接続方式 Type Of Connection	最高使用圧力 (MPa) Max. Working Pressure	最大流量 (L/min) Max. Flow Rate	質量 (Kg) Mass
HRV-G02-25-21	ガasket形 Gasket Type	25	40	1.0
HRV-G03-25-11			60	2.0
HRV-G06-25-11			120	3.6
HRV-G10-25-11			250	6.5

モデルNo. Model Number	接続方式 Type Of Connection	最高使用圧力 (MPa) Max. Working Pressure	最大流量 (L/min) Max. Flow Rate	質量 (Kg) Mass		
				制御ポートの記号 Control Port Symbol		
				A	B	W
HRV-M01-* -25-21	モジュラー形 Module Type	25	40	1.45	2.0	
HRV-M03-* -25-21			60	3.5	3.9	
HRV-M06-* -25-21			120	10	10.5	
HRV-M10-* -25-21			250	32.7	33	

ガスケット取付形 GASKET TYPE

HRV-G02-25-21

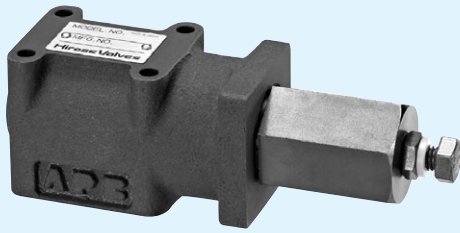

油圧記号

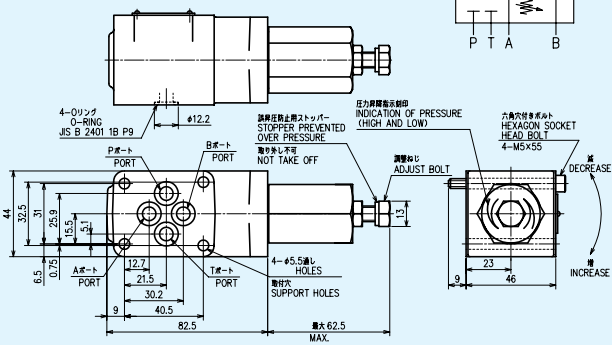
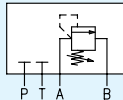

HRV-G03-25-11

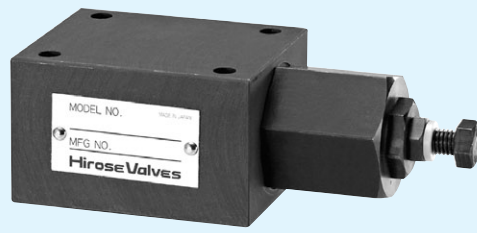

油圧記号

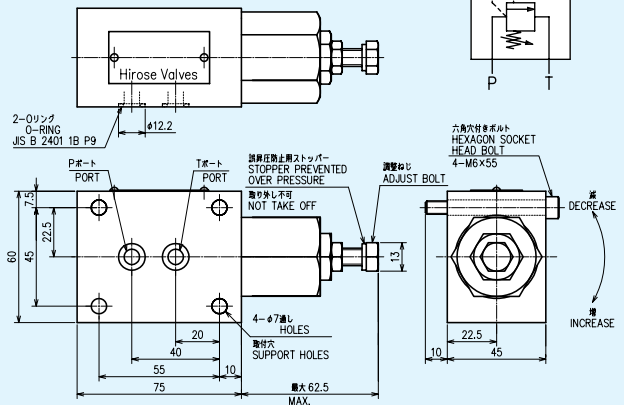
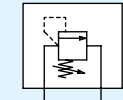

HRV-G06-25-11

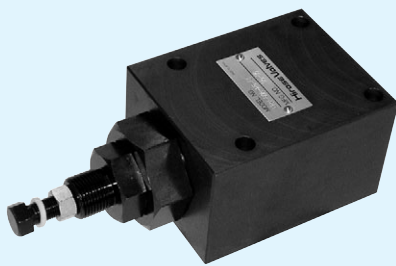

油圧記号

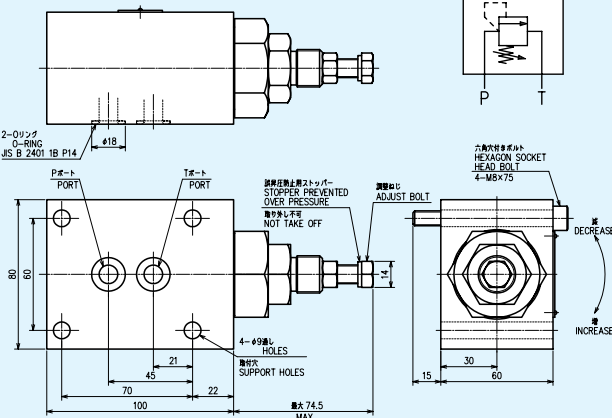
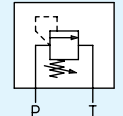

HRV-G10-25-11

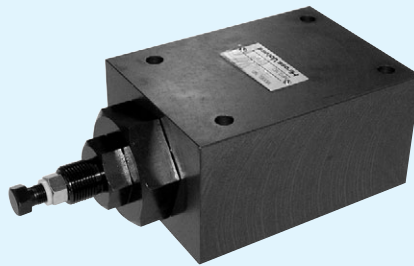

油圧記号

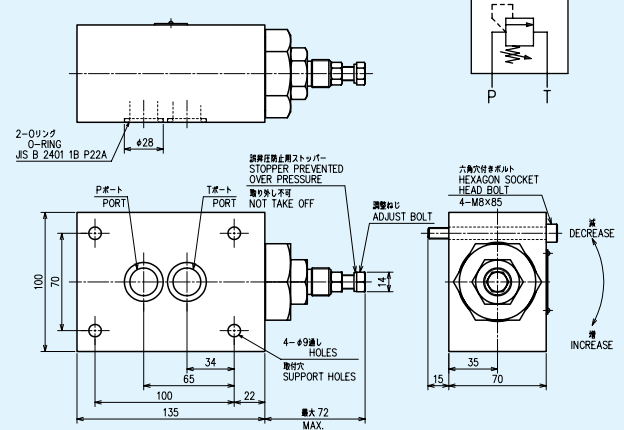
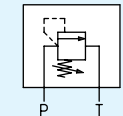

モジュラー取付形 MODULAR TYPE

HRV-M01-* -25-21

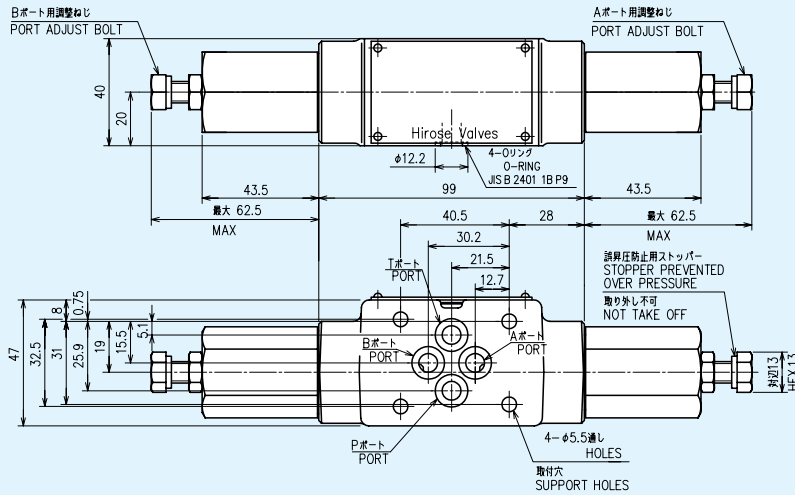

HRV-M01-W-25-21の場合
IN CASE OF HRV-M01-W-25-21

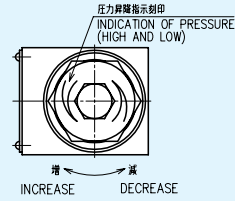
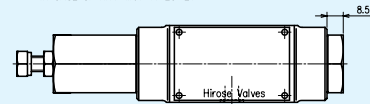
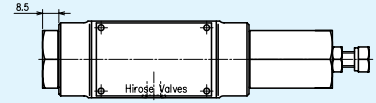

油圧記号

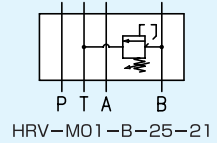
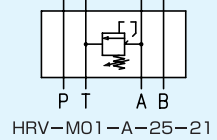
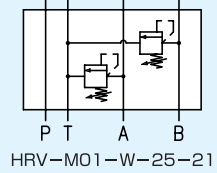

HRV-M03-* -25-21

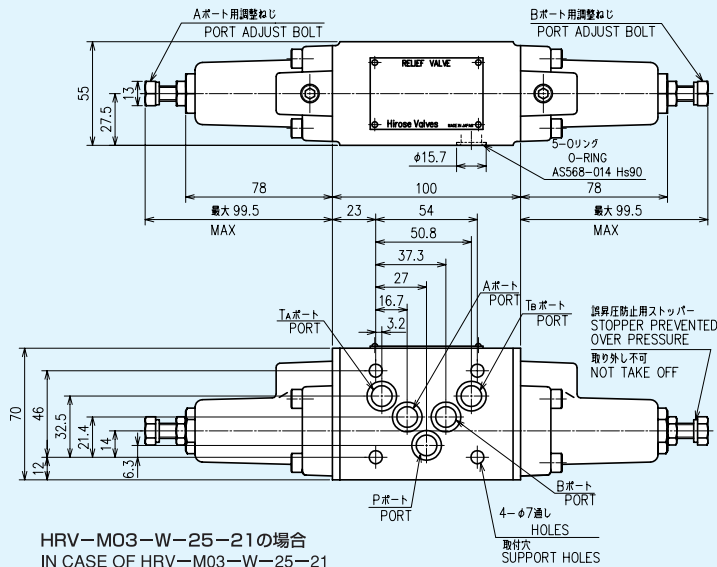
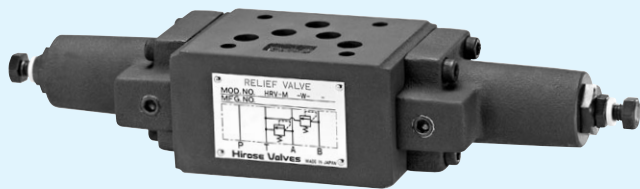

HRV-M03-W-25-21の場合
IN CASE OF HRV-M03-W-25-21

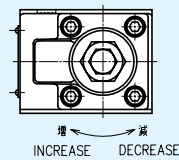
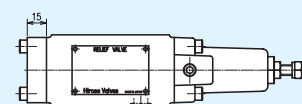
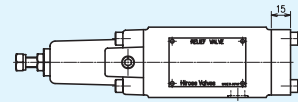

油圧記号

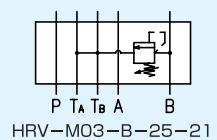
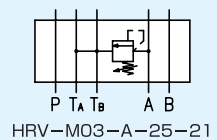
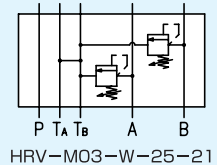

HRV-M06-* -25-21

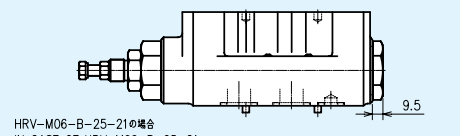
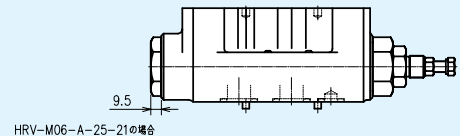
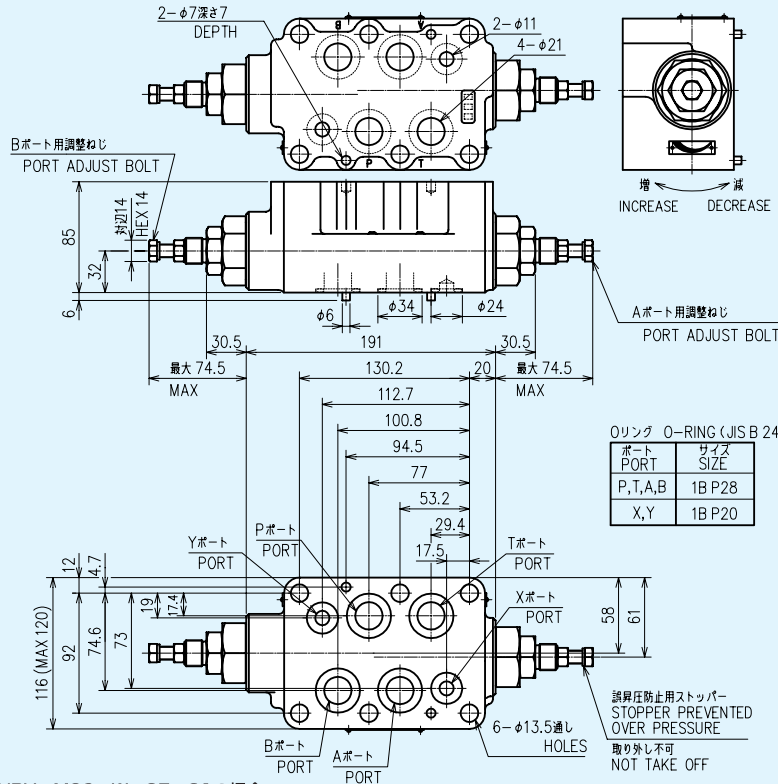

油圧記号

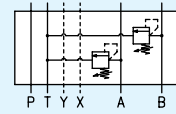

HRV-M06-W-25-21

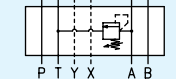

HRV-M06-A-25-21

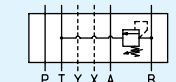

HRV-M06-B-25-21

HRV-M06-W-25-21の場合
IN CASE OF HRV-M06-W-25-21

HRV-M10-* -25-21

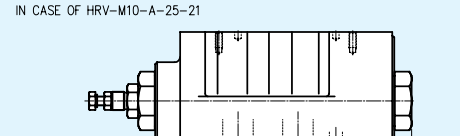
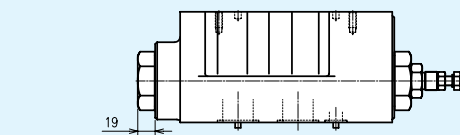
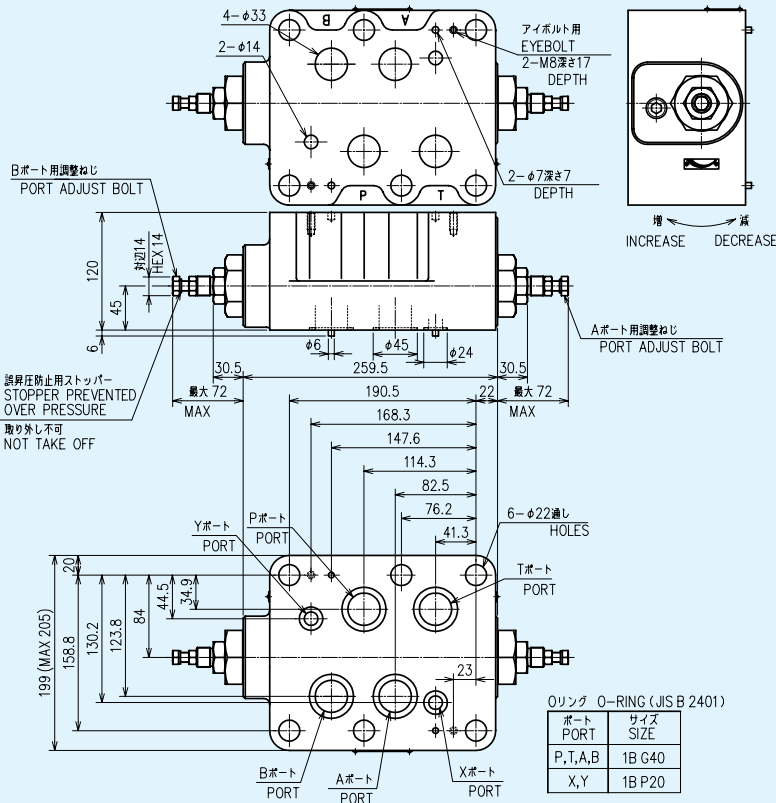

油圧記号

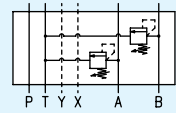

HRV-M10-W-25-21

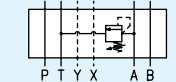

HRV-M10-A-25-21

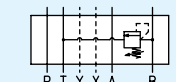

HRV-M10-B-25-21

HRV-M10-W-25-21の場合
IN CASE OF HRV-M10-W-25-21

圧力オーバーライド特性線図 ISO-VG46 40°C Flow Characteristic Chart

HRV-G02-25-21
HRV-M01-* -25-21

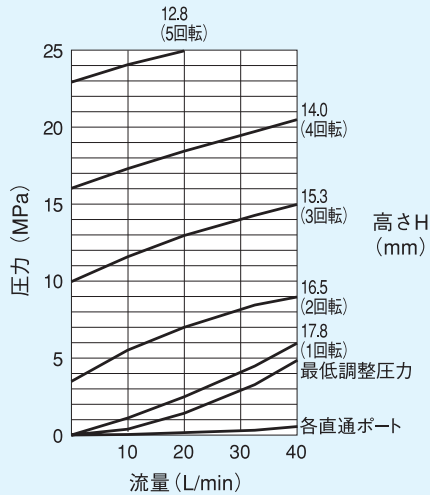
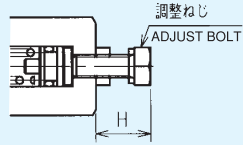

HRV-G03-25-11
HRV-M03-* -25-21

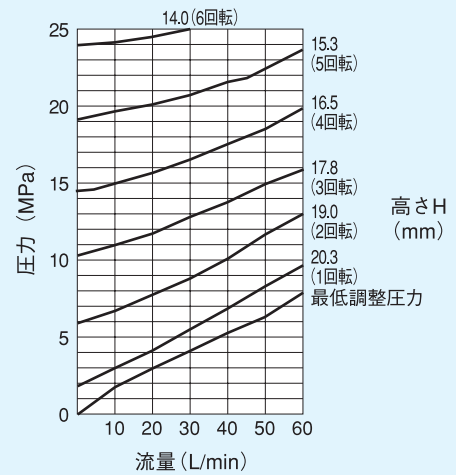
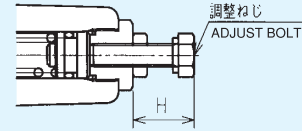

HRV-G06-25-11
HRV-M06-* -25-21

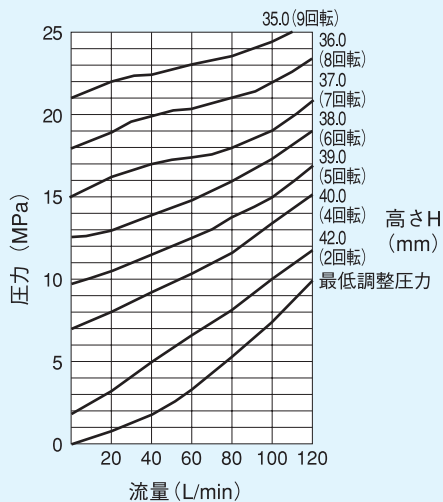
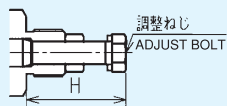

HRV-G10-25-11
HRV-M10-* -25-21

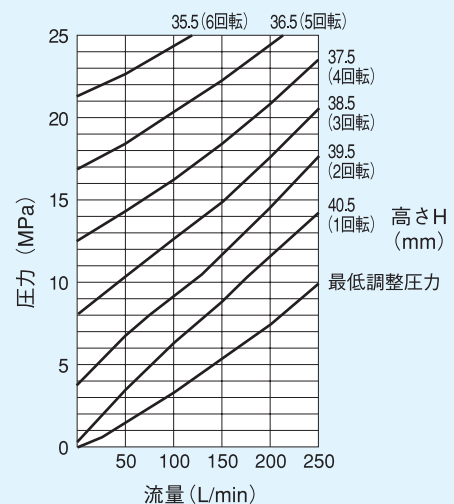
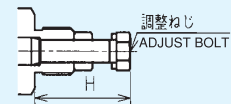

※調整ねじ高さHは参考値を示しております。

高圧用 (31.5、35MPa) 直動形リリーフバルブ

モジュラー取付形 MODULAR TYPE

バルブ仕様 Valve Specifications

モデルNo. Model Number	呼び径 Size	最高使用圧力 (MPa) Max. Working Pressure	最大流量 (L/min) Max. Flow Rate
HRV-M03-* -31-21	03	31.5	60
HRVH-M01-* -35-21	01	35	40

HRV-M03-* -31-21

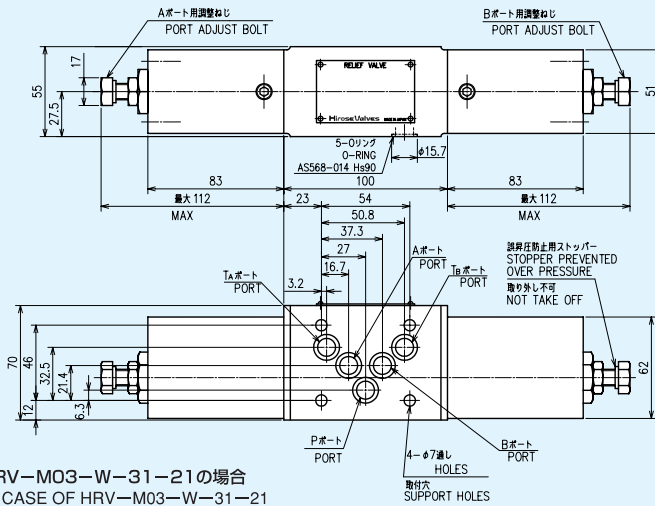

HRV-M03-W-31-21の場合
IN CASE OF HRV-M03-W-31-21

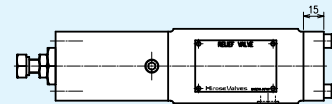

HRV-M03-A-31-21の場合
IN CASE OF HRV-M03-A-31-21

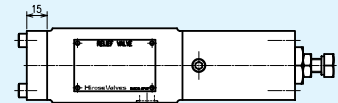

HRV-M03-B-31-21の場合
IN CASE OF HRV-M03-B-31-21

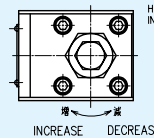

油圧記号

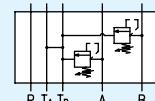

HRV-M03-W-31-21

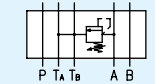

HRV-M03-A-31-21

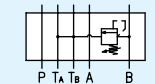

HRV-M03-B-31-21

HRVH-M01-* -35-21

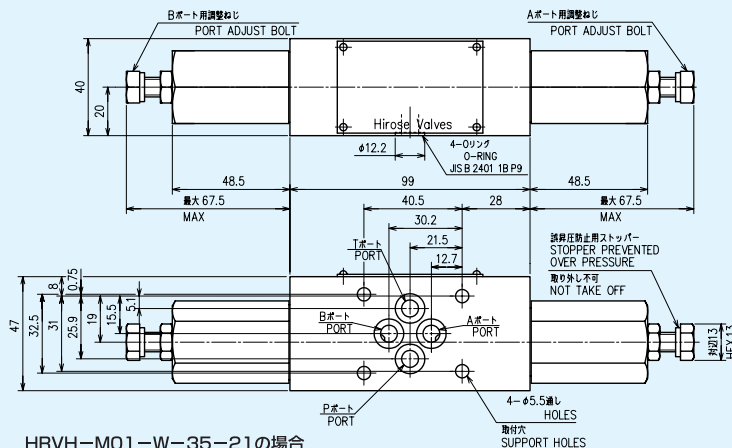
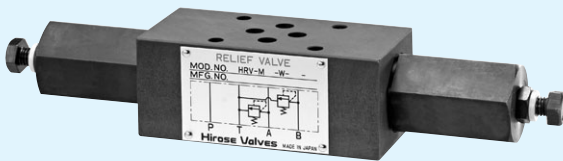

HRVH-M01-W-35-21の場合
IN CASE OF HRVH-M01-W-35-21

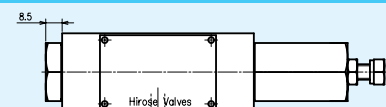

HRVH-M01-A-35-21の場合
IN CASE OF HRVH-M01-A-35-21



HRVH-M01-B-35-21の場合
IN CASE OF HRVH-M01-B-35-21

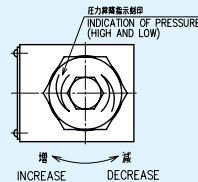

油圧記号

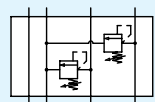

HRVH-M01-W-35-21

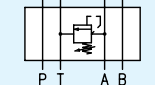

HRVH-M01-A-35-21

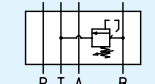

HRVH-M01-B-35-21

※流量特性、その他詳細につきましては、別途お問い合わせ願います。

このカタログの製品を実際に取り扱う場合は、必ず当該製品の取扱説明書をお読みになり、常に安全を第一に考えて製品を取り扱ってください。

(●このカタログ記載の注意事項および警告は全ての場合を網羅していません。)

重大事故や人身事故を避けるために本注意事項および関連規格の安全に関する法規類を必ず守ってください。

Before you use the product, you MUST read the instruction manual and MUST fully understand how to use the product.

To use the product safely, you MUST carefully read all Warnings and Cautions in this manual. You MUST also observe the related regulations and rules regarding safety.

⚠ 使用上の注意

⚠ Cautions in use

- ⚠ 警告 最高使用圧力以下でご使用ください。
- ⚠ 警告 最大流量以下でご使用ください。
- ⚠ 注意 一般鉱油系作動油をご使用ください。
このカタログのモデルナンバーは一般鉱油系作動油をご使用の場合を示します。
その他の作動油をご使用される場合は当社までお問い合わせください。
作動油は常に清浄(汚染度:NAS12級以内)に保ってください。
- ⚠ 注意 作動油は粘度範囲15~400mm²/sでご使用ください。
- ⚠ 注意 作動油は油温範囲-15~80℃でご使用ください。
上記温度範囲外でご使用される場合は当社までお問い合わせください。
- ⚠ 注意 お客様による弁の改造は、絶対にしないでください。
- ⚠ 注意 弁は断りなく分解、組み直しをしないでください。
定められた性能を発揮できず、故障や事故の原因になります。

- ⚠ WARNING Use the valve at maximum working pressure or below.
- ⚠ WARNING Use the valve at maximum flow rate or below.
- ⚠ CAUTION Use general mineral oil series hydraulic oil. The valve model No. described in this catalogue is subject to use of general mineral series hydraulic oil.
Contact us for use of other different hydraulic oil.
Keep hydraulic oil clean (cleanliness: NAS Grade 12 or below).
- ⚠ CAUTION This valve shall be used in the range of an oil temperature between minus 15 and 80°C and of viscosity between 15 and 400mm²/s. In case of using the valve beyond this range, consult with us.
Contact us for the use at temperature beyond the above temperature range.
Using the valve out of conditions instructed above could result in mechanical and/or physical damage, leading to a serious accident.
- Warnings and Cautions for operation
- ⚠ CAUTION Keep your body off the product during the operations as it may become hot and burn your body.
- Cautions related to maintenance
- ⚠ CAUTION Never modify the VALVES.
- ⚠ CAUTION Do not disassemble and assemble. It may cause troubles and failure, or it may not work as specified.

※本カタログは当社が必要とする事由により、予告なく改訂されることがあります。
カタログ表紙上段にCAT.NO.を記載しております。製品ご選定の際には、最新版であるか当社までご確認ください。

※Materials and specifications are subject to change without manufacture's obligation.



Ⓩ 廣瀬バルブ工業株式会社

本社・工場 滋賀県彦根市安清町2番34号 TEL 0749 (23) 2020(代)
〒522-0082 FAX 0749 (23) 2027番
中部営業所 TEL 0749 (23) 5450番
東京営業所 東京都港区芝大門2-4-1 IZUMIビル TEL 03 (3437) 0011(代)
〒105-0012 FAX 03 (3437) 0013番
大阪営業所 大阪府北区南扇町7-20 宝山ビル新館 TEL 06 (6312) 2412(代)
〒530-0052 FAX 06 (6316) 1236番

U R L <http://www.hirose-valves.co.jp>
E-mail info@hirose-valves.co.jp

Hirose Valve Industry Co., Ltd.

Head Office & Plant:
34, 2-Ban, Yasukiyo-cho, Hikone, Shiga-ken, Japan
Phone: Hikone 0749-23-2020~5 Fax: 0749-23-2027
Tokyo Office:
Izumi Bldg., 1-4-2 Chome, Shiba-daimon, Minato-ku, Tokyo
Phone: Tokyo 03-3437-0011~2 Fax: 03-3437-0013
Osaka Office:
Shin Hozan Bldg., 20-7 Minami Ohgimachi, Kita-ku, Osaka
Phone: Osaka 06-6312-2412~3 Fax: 06-6316-1236